

Timber reveal

Subframe

Subsill+subhead



SS Flydoor



Single glass



Double glazed

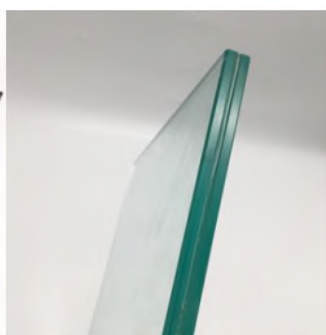

Laminated glass

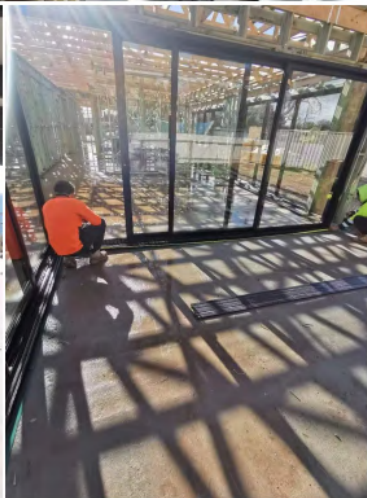

HDT101 Sliding Door

Product Brief Introduction

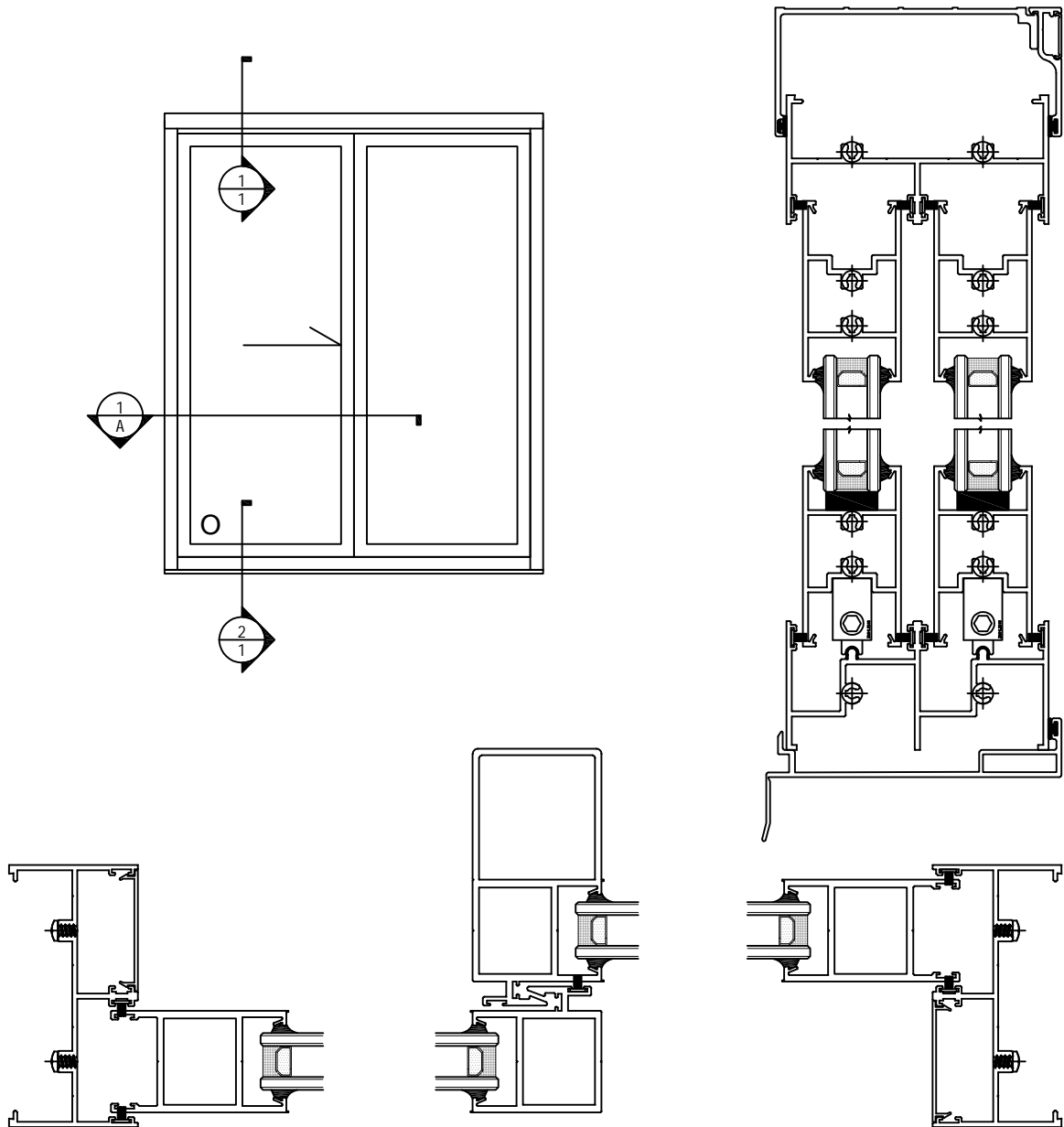

COMPATIBLE WITH

- C101 Series Window.
- H35 Series Hinged Door.
- H45 Series Hinged Door.

Features & Benefits

- 101.6mm X 50mm Frame.
- Architectural Applications.
- Supports Single Glazing.
- Compatible Door And Window.

GLAZING DETAILS

- 5Clr/12Ar/ 5Clr
- 5Obs /12Ar/ 5Clr
- 5Low-E/12Ar/ 5Clr
- 6Clr/12Ar/ 6Clr
- 6Obs /12Ar/ 6Clr
- 6Low-E/12Ar/ 6Clr

PRODUCT SPECS

Max.Recommended Sizes

- Height: 3000
- Width: 4000

Max.Product Performance

- Water (PA): Null

HDT101 Sliding Door

Product form

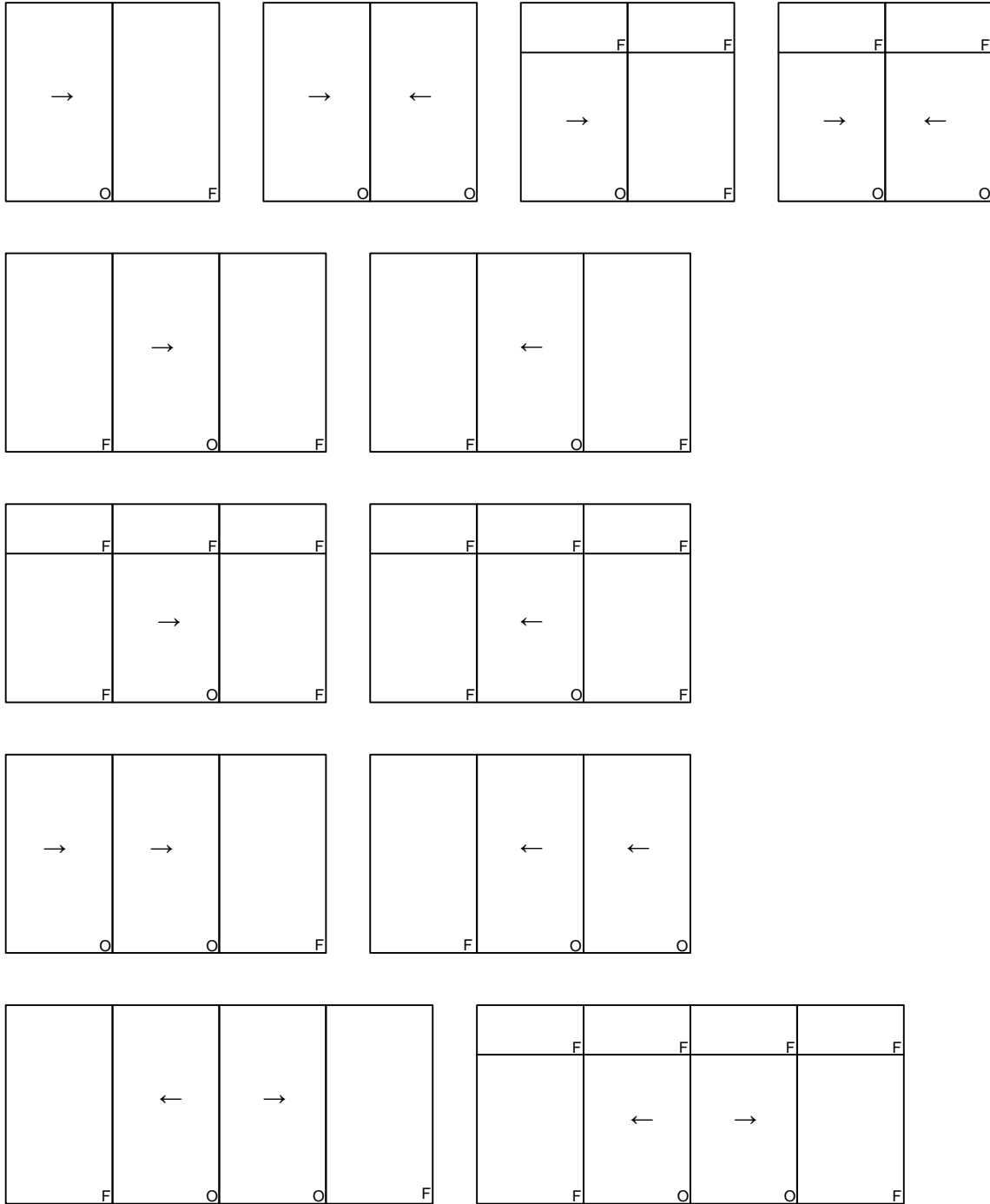

HDT101 Sliding Door

Product Detail

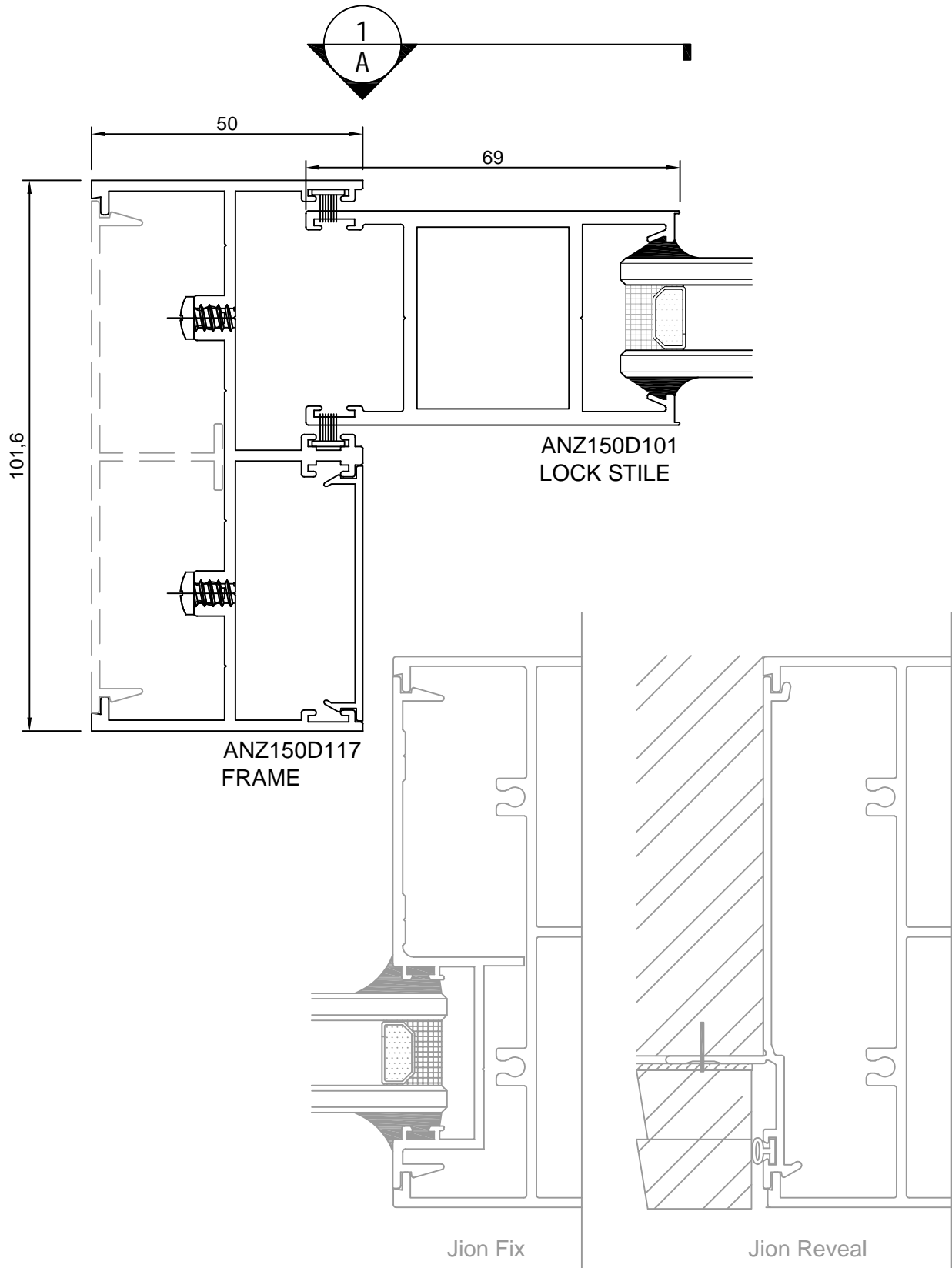

HDT101 Sliding Door

Product Detail

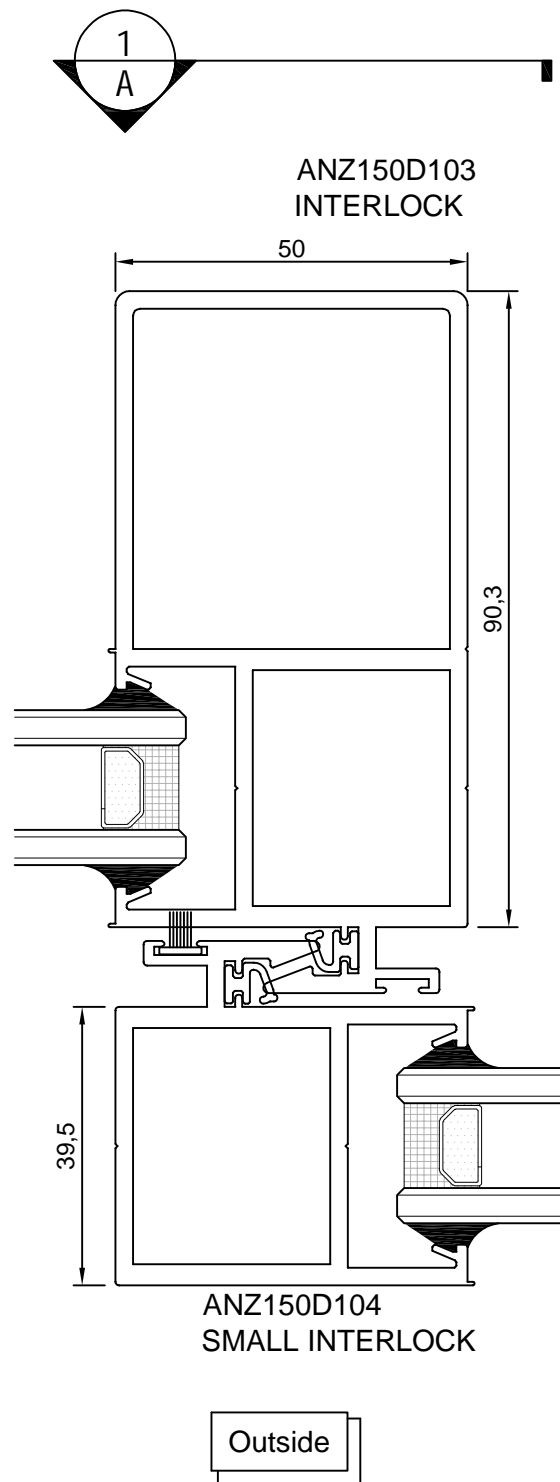

HDT101 Sliding Door

Product Detail

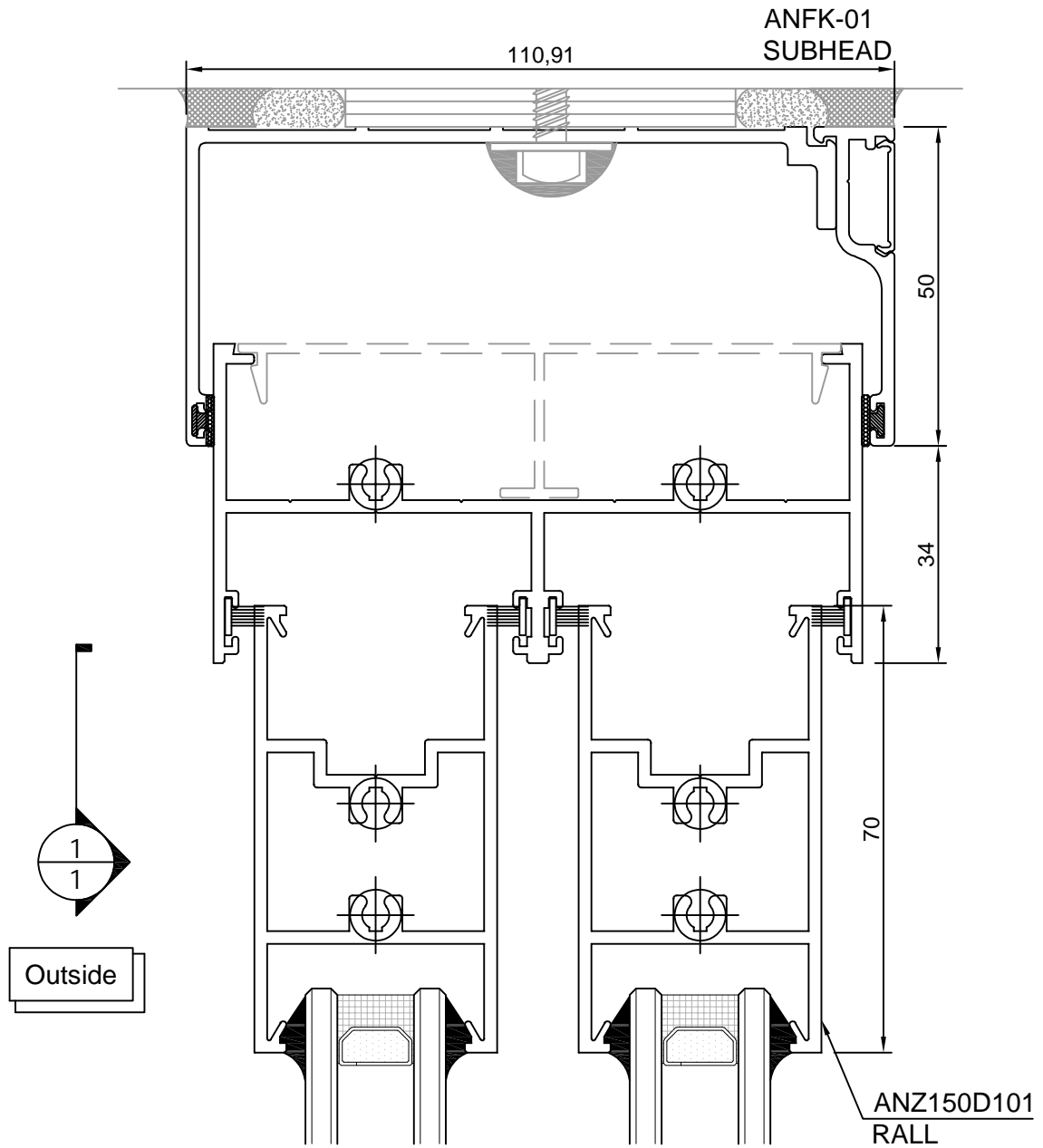

HDT101 Sliding Door

Product Detail

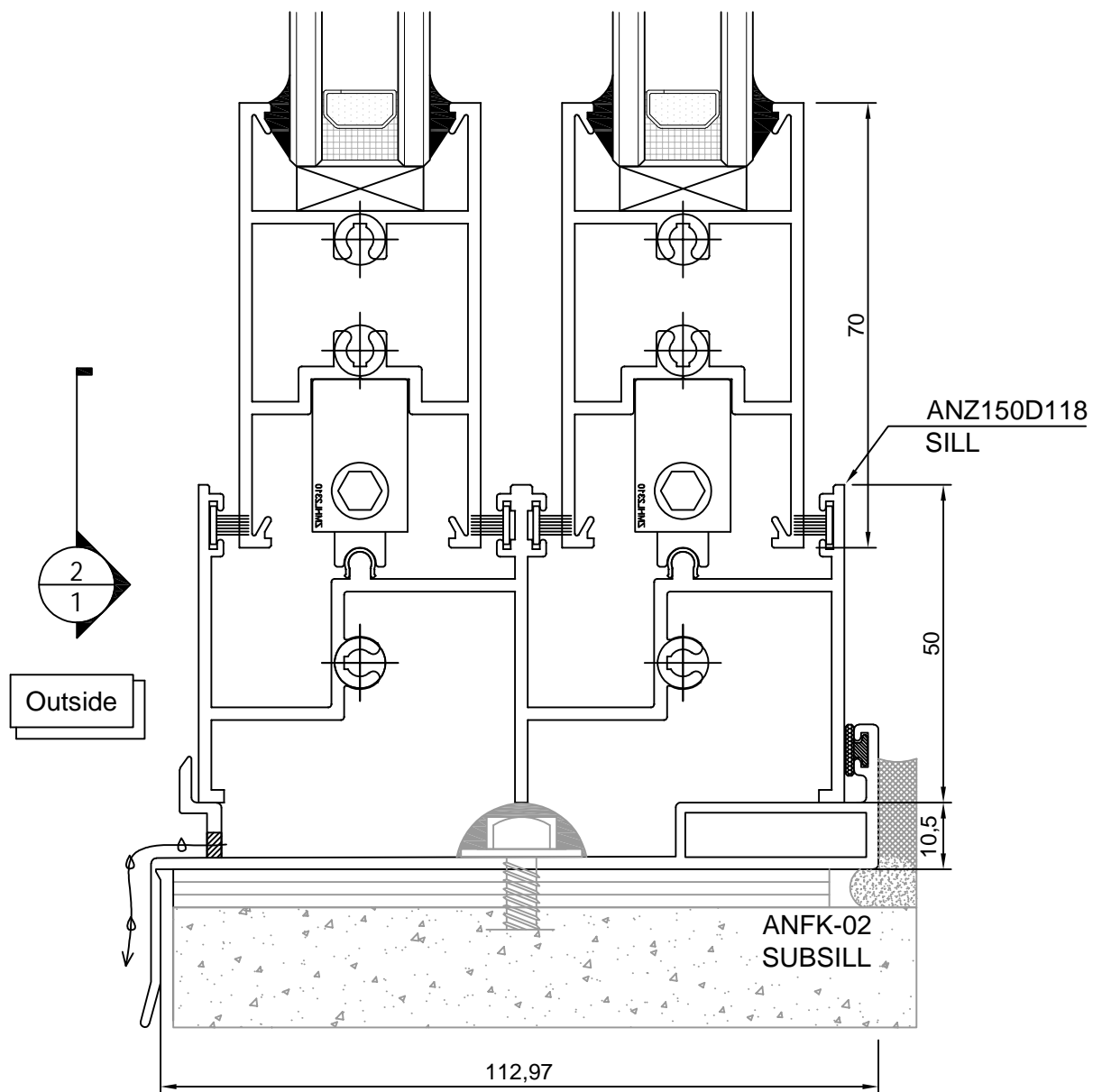

HDT101 Sliding Door

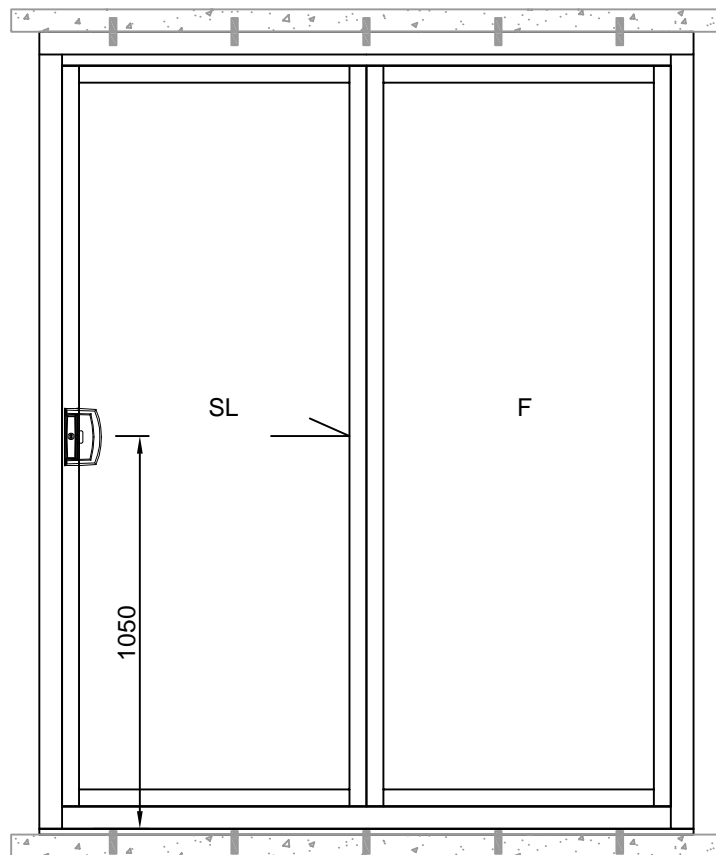

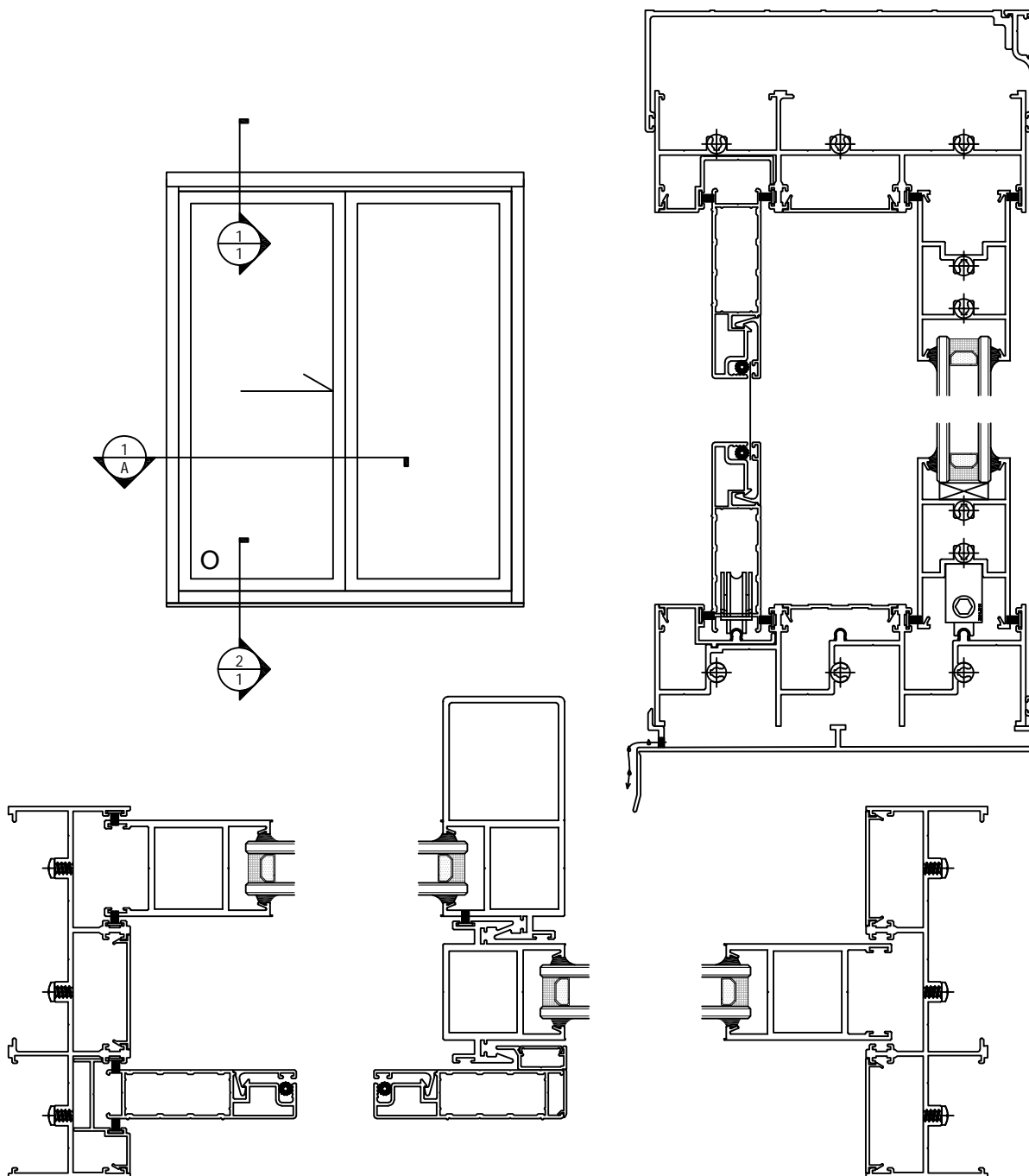

COMPATIBLE WITH

Features & Benefits

- 152.4mm X 50mm Frame.
- Architectural Applications.
- Supports Single Glazing.
- Compatible Door And Window.

GLAZING DETAILS PRODUCT SPECS

- 5Clr/12Ar/ 5Clr
- 5Obs /12Ar/ 5Clr
- 5Low-E/12Ar/ 5Clr
- 6Clr/12Ar/ 6Clr
- 6Obs /12Ar/ 6Clr
- 6Low-E/12Ar/ 6Clr

Max.Recommended Sizes

- Height: 3000
- Width: 4000

Max.Product Performance

- Water (PA): Null

HDT150 Sliding Door

Product form

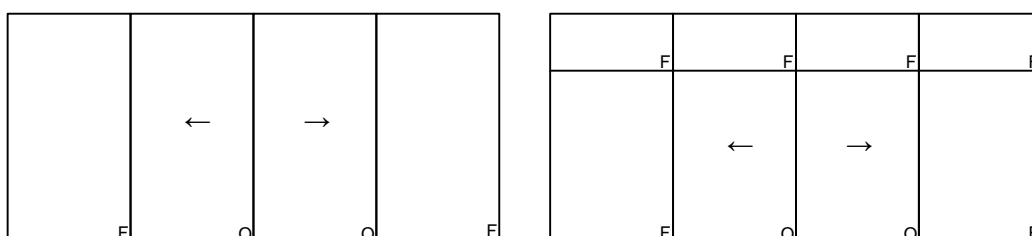
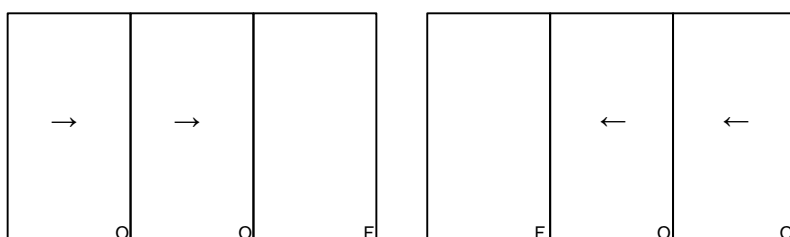
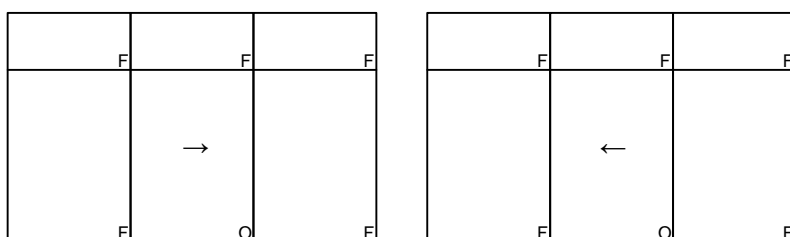
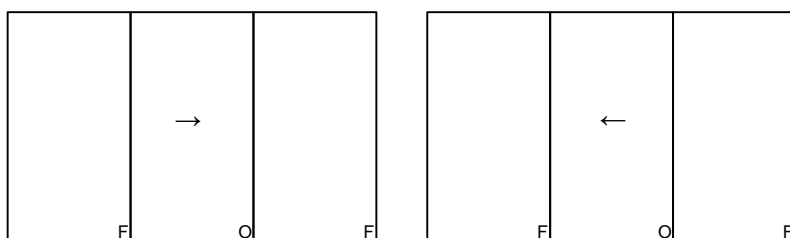
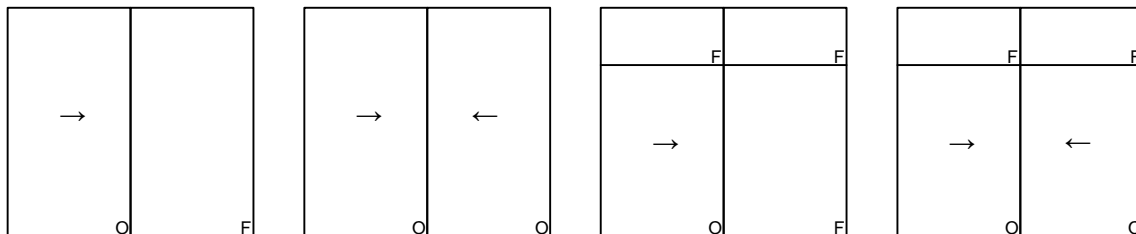

HDT150 Sliding Door

Product Detail

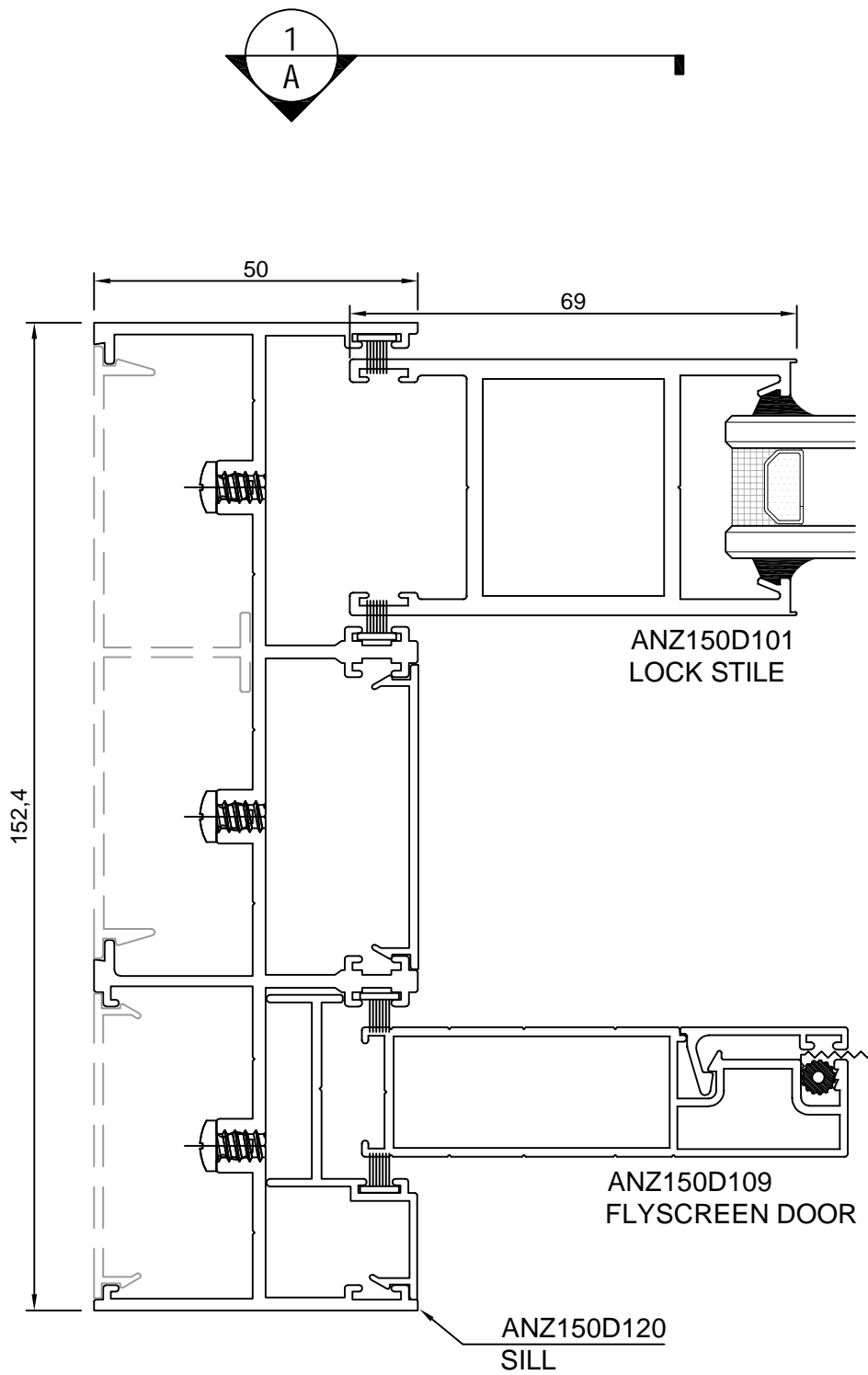

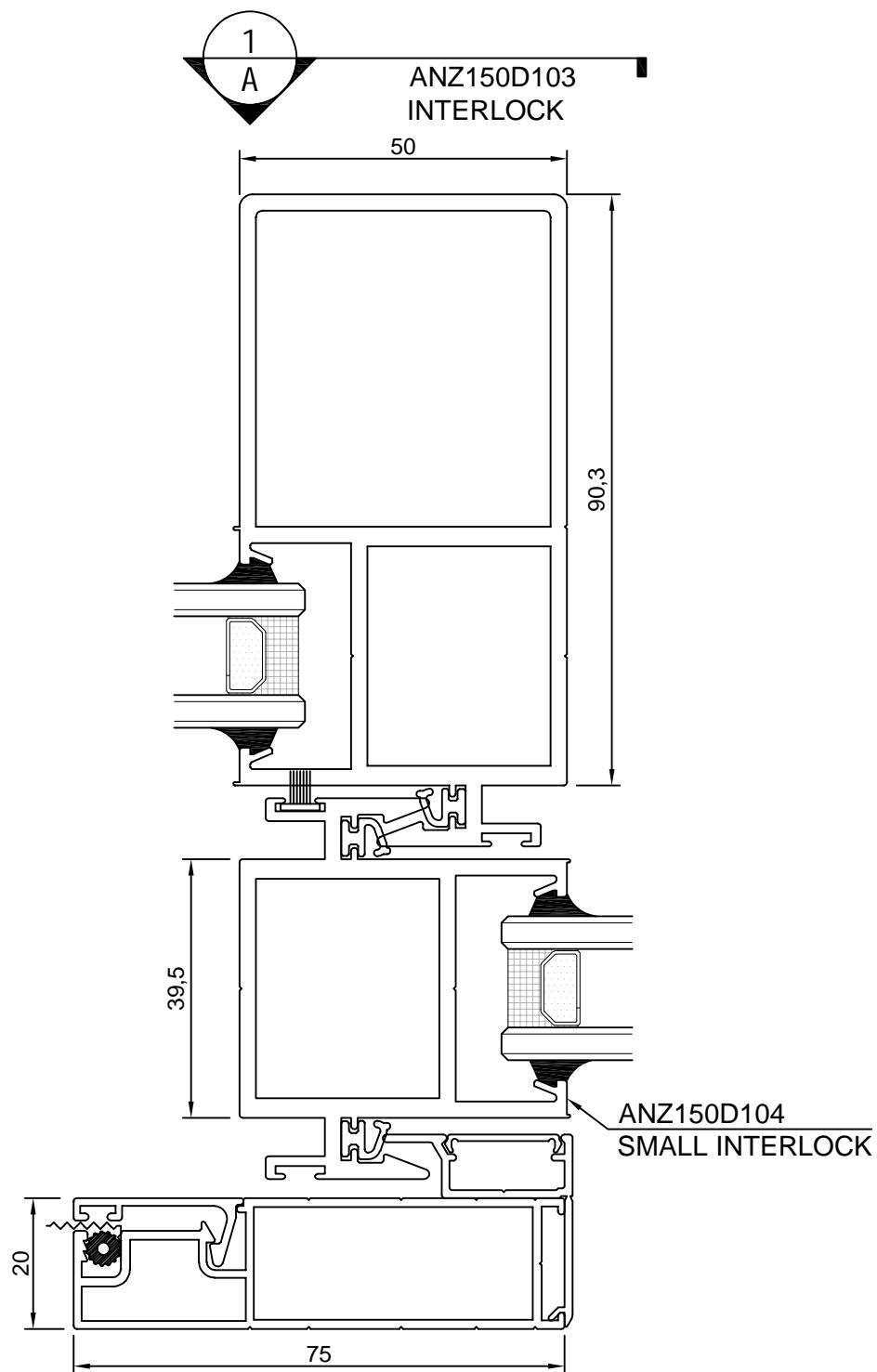

HDT150 Sliding Door

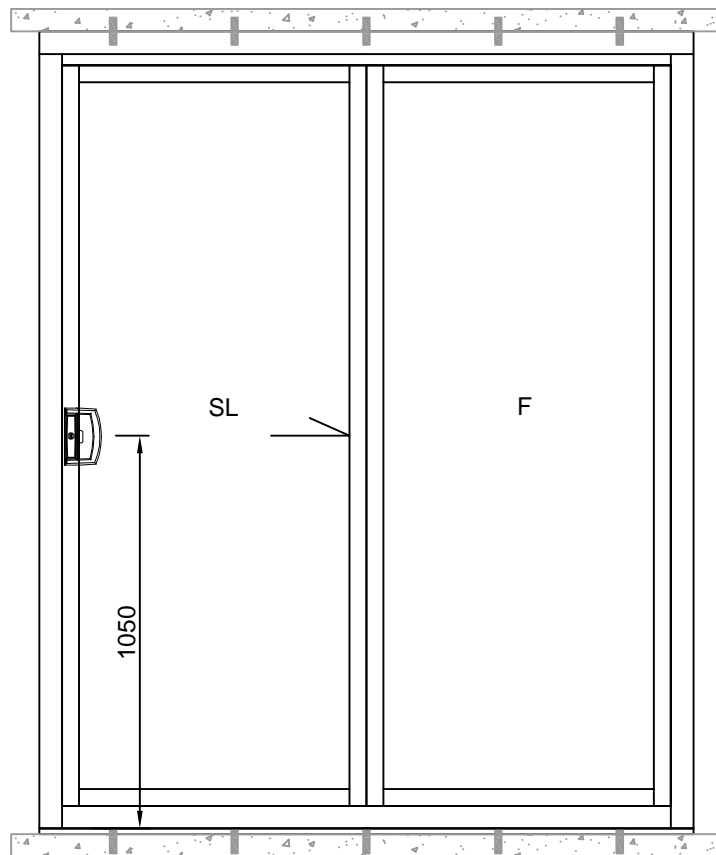

HDT150 Sliding Door

Product Detail

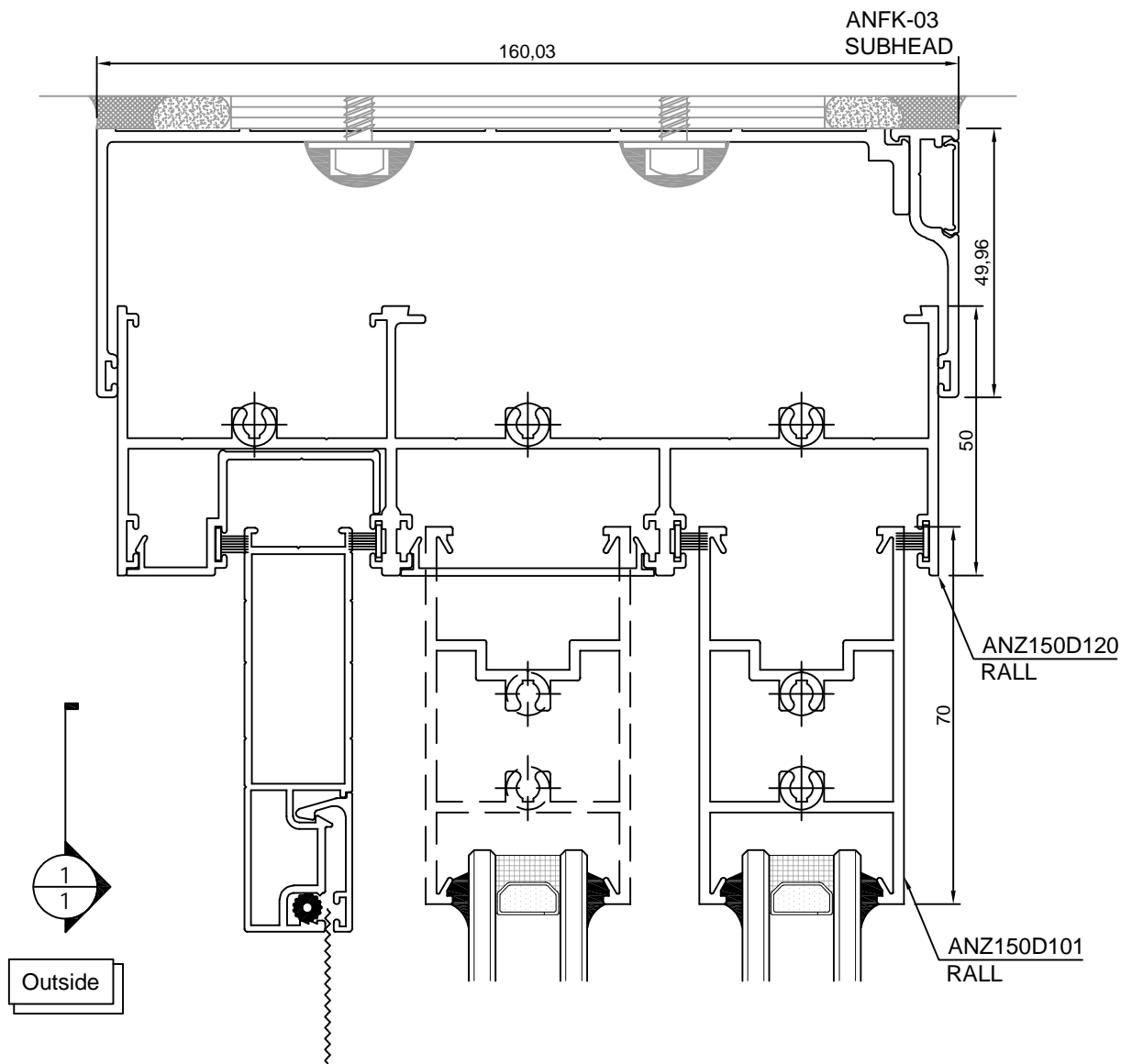

HDT150 Sliding Door

Product Detail

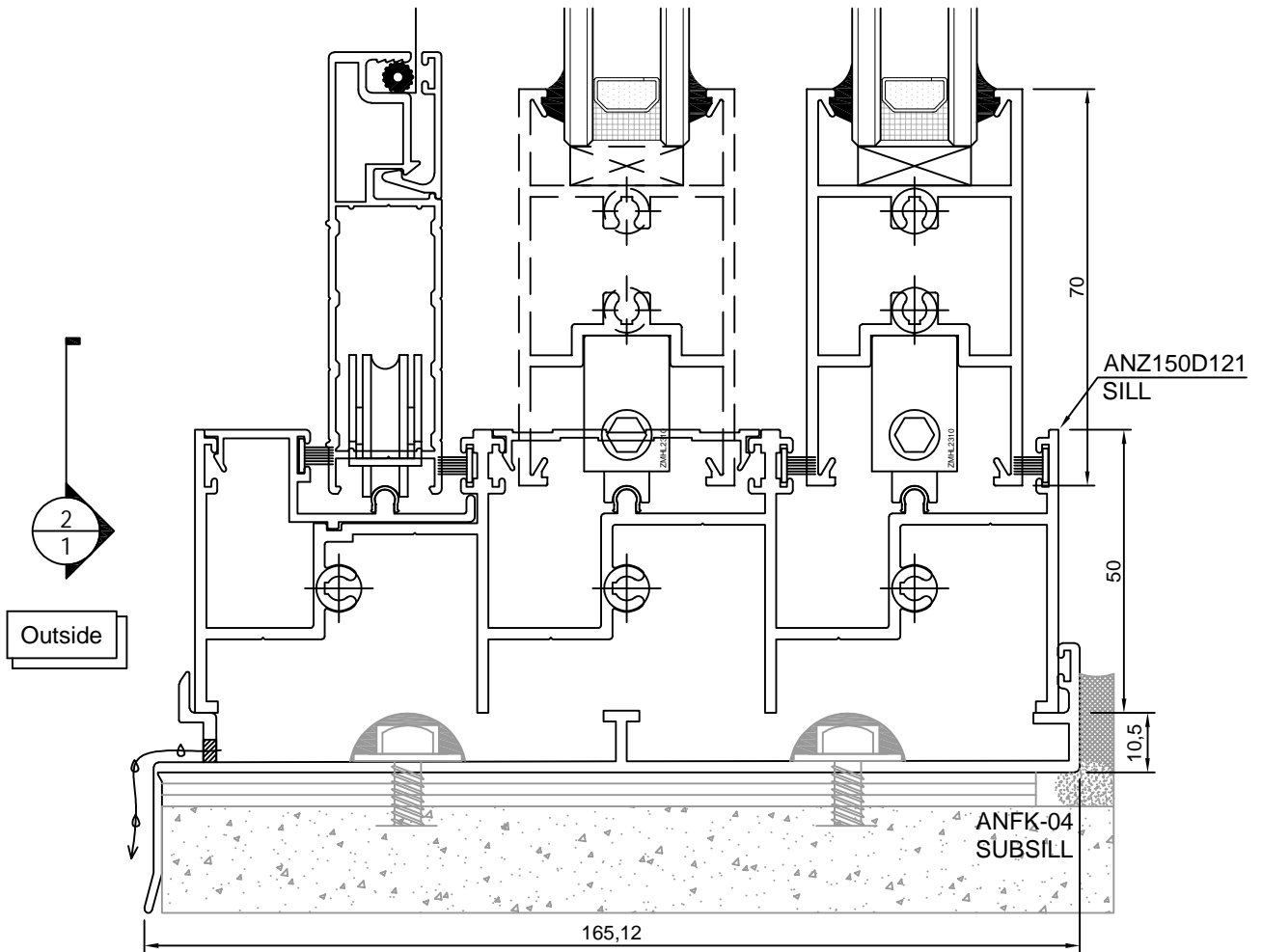

HDT150 Corner Stacker Door

< OUTSIDE

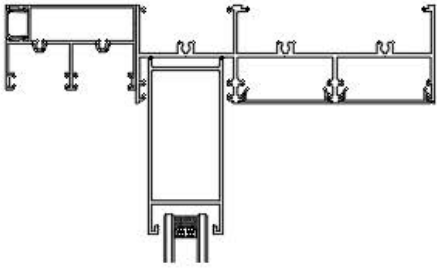

< OUTSIDE

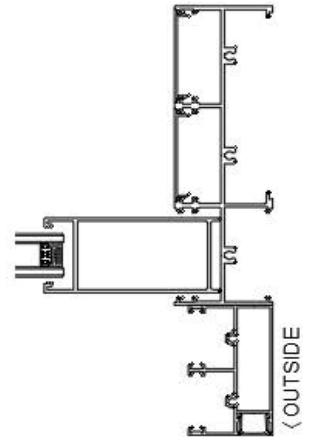
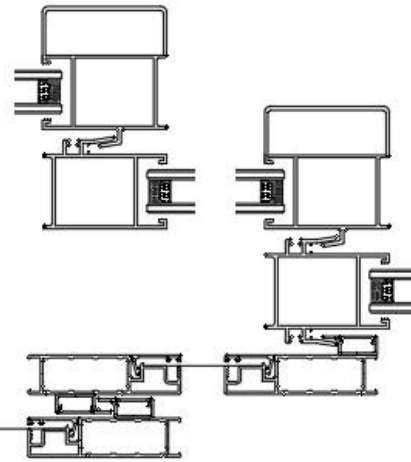
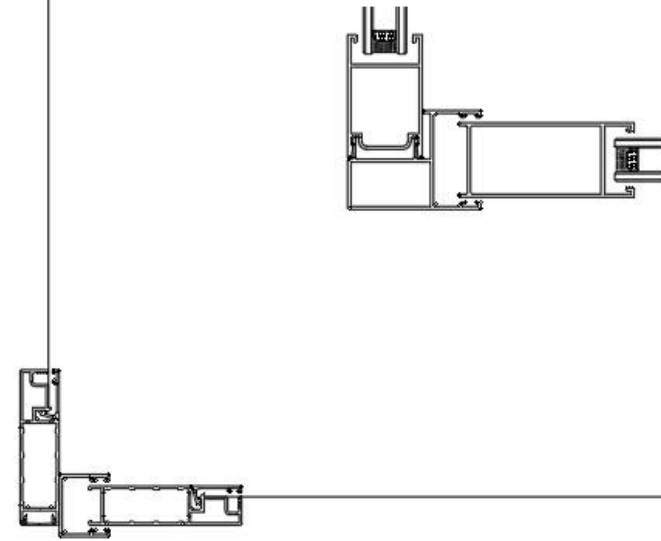
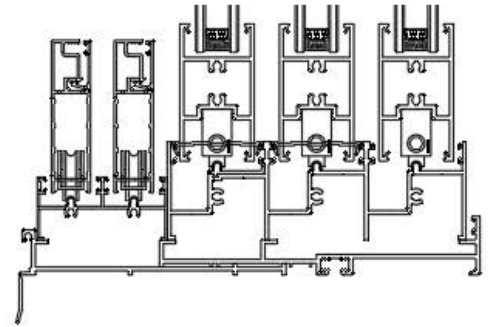
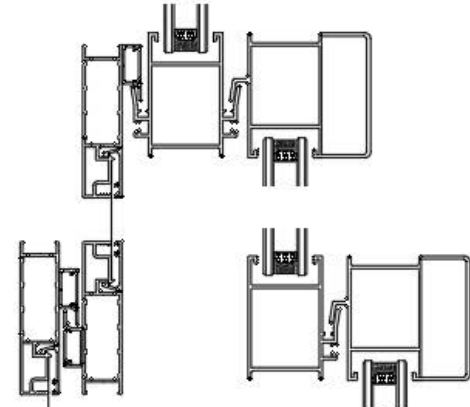
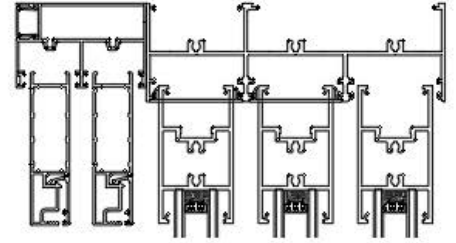

< OUTSIDE

PRODUCT: Heavy Sliding Door (5 Trade)

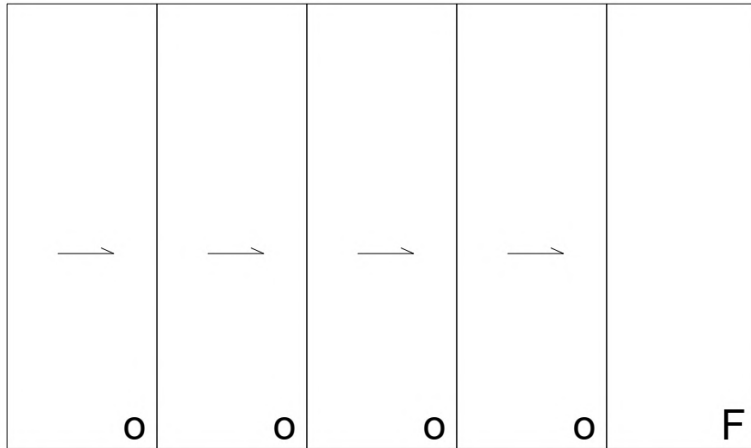

DOUBLE GLAZED:
5Clr/12Ar/5Clr
CONVENTIONAL SIZE

