

Timber reveal

Subframe

Subsill+subhead



SS Flydoor

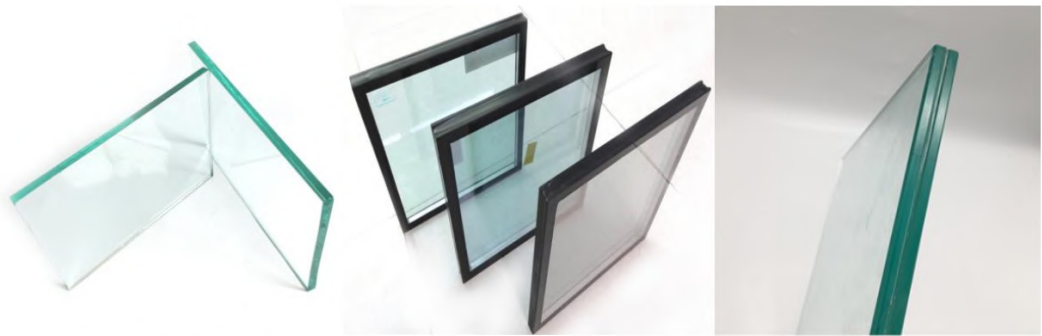

Single glass

Double glazed

Laminated glass

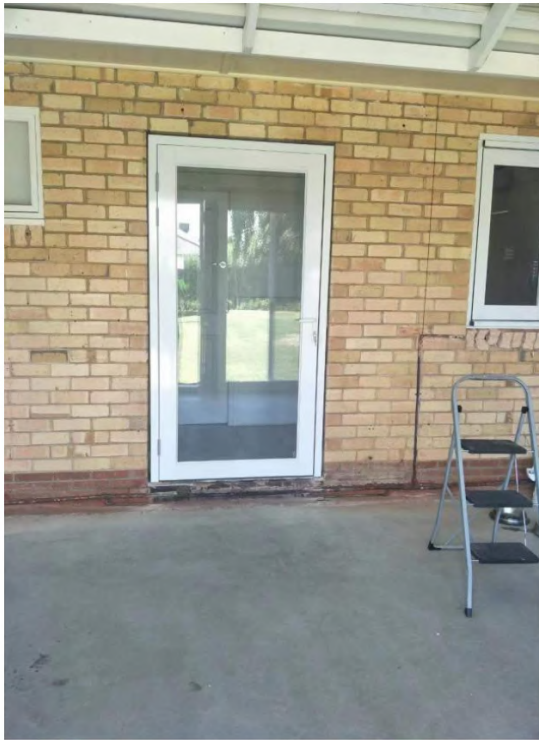

H45 Hinged Door

Product Brief Introduction

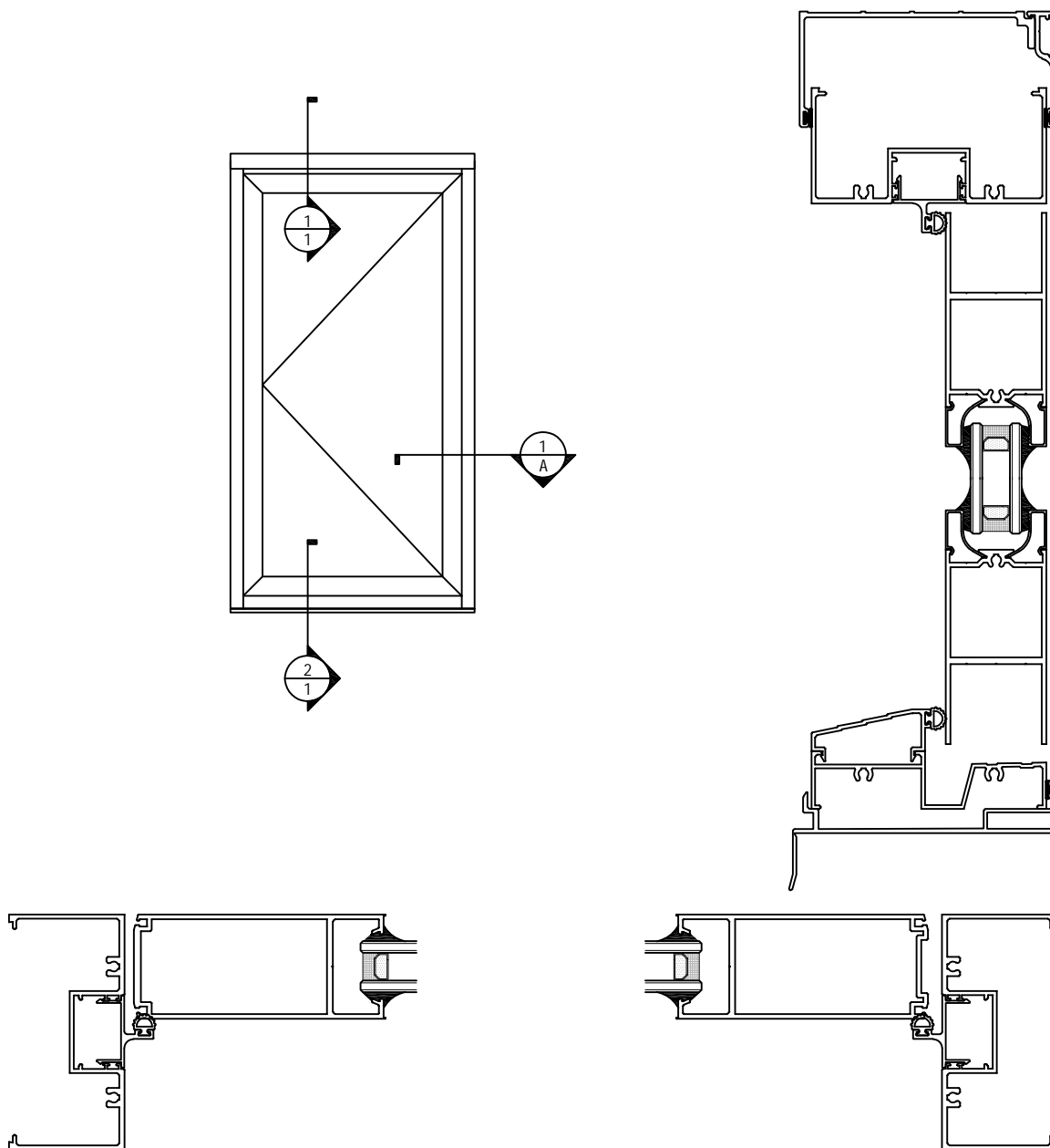

COMPATIBLE WITH

- C101 Series Fix Window.
- T101 Series Sliding Door.
- HDT101 Series Sliding Door.

Features & Benefits

- 101.6mm X 50mm Frame.
- Architectural Applications.
- Supports Single Glazing.
- Compatible Door And Window.

GLAZING DETAILS

- 10.78Lam
- 5Clr;5Obs
- 6Clr;6Obs
- 5Clr/12Ar/ 5Clr
- 5Obs /12Ar/ 5Clr
- 5Low-E/12Ar/ 5Clr
- 6Clr/12Ar/ 6Clr
- 6Obs /12Ar/ 6Clr
- 6Low-E/12Ar/ 6Clr

PRODUCT SPECS

Max.Recommended Sizes

- Height: 2500
- Width: 1050

Max.Product Performance

- Water (PA): 150 Pa

H45 Hinged Door

Product form

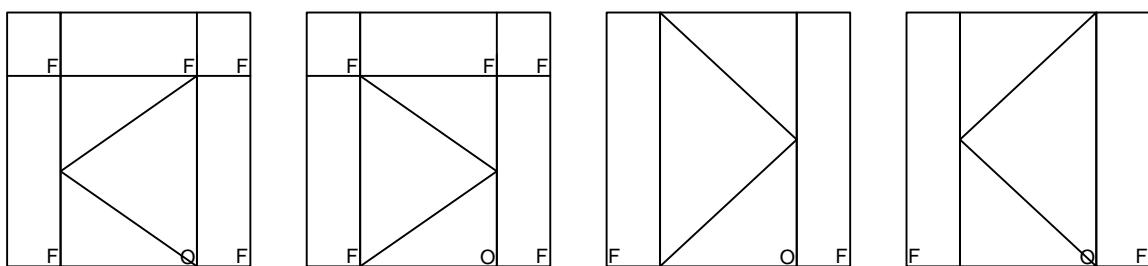
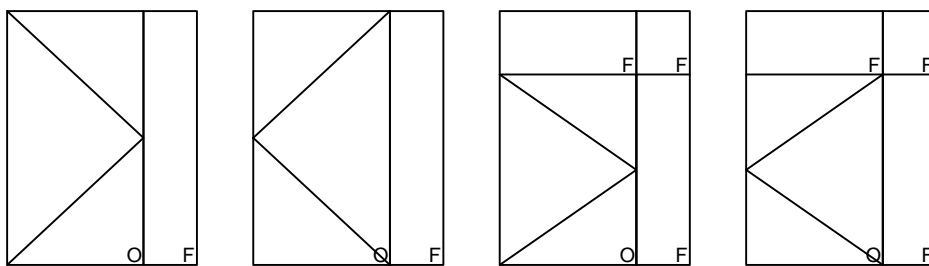
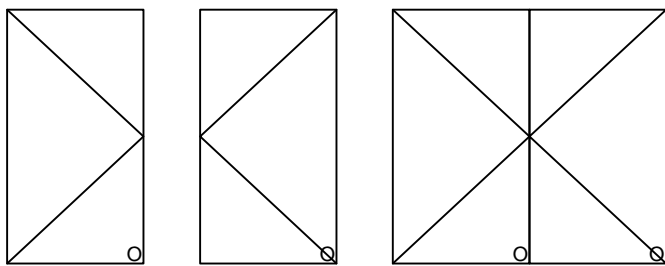

H45 Hinged Door

Product Detail

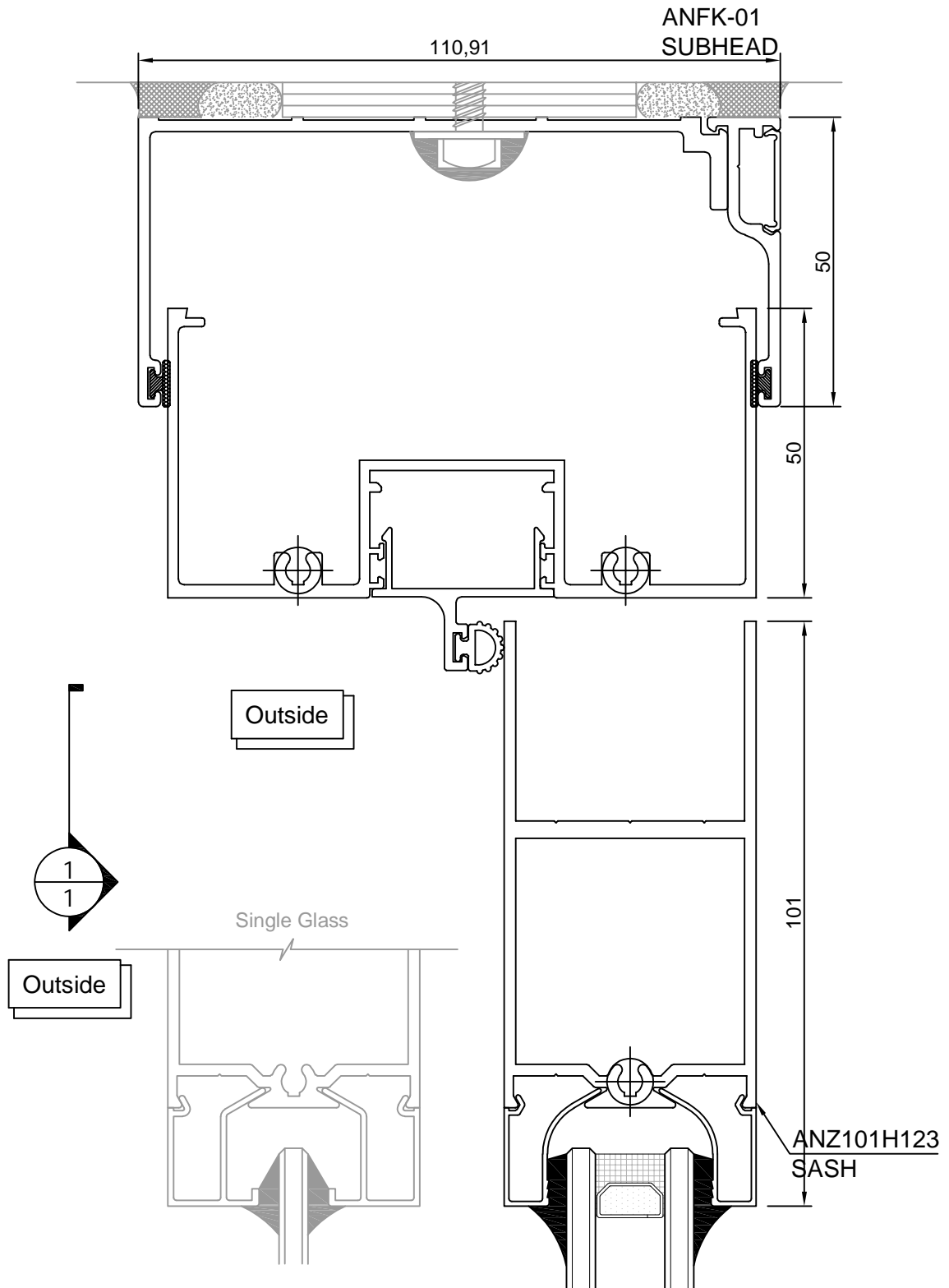

H45 Hinged Door

Product Detail

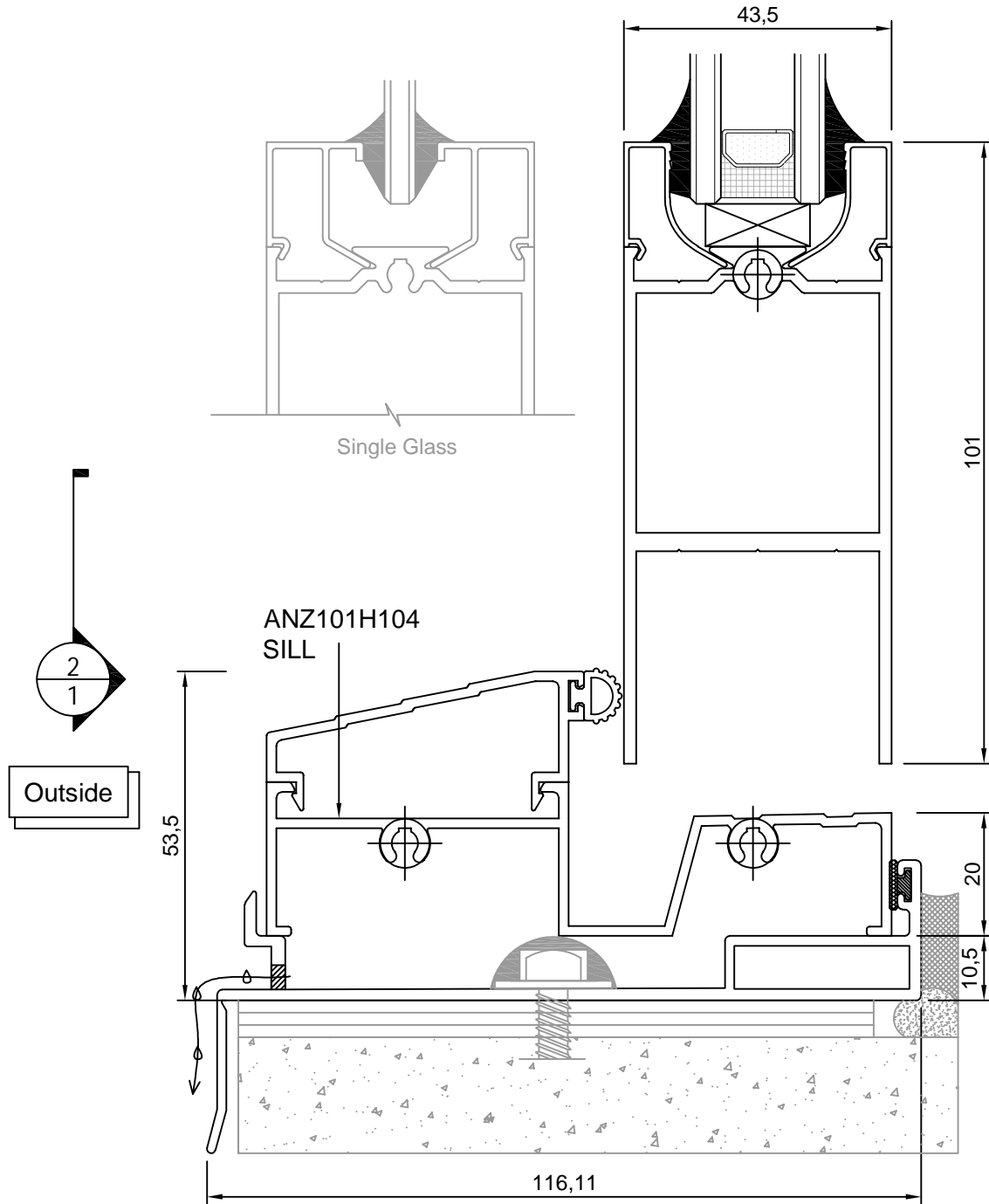

H45 Hinged Door

Product Detail

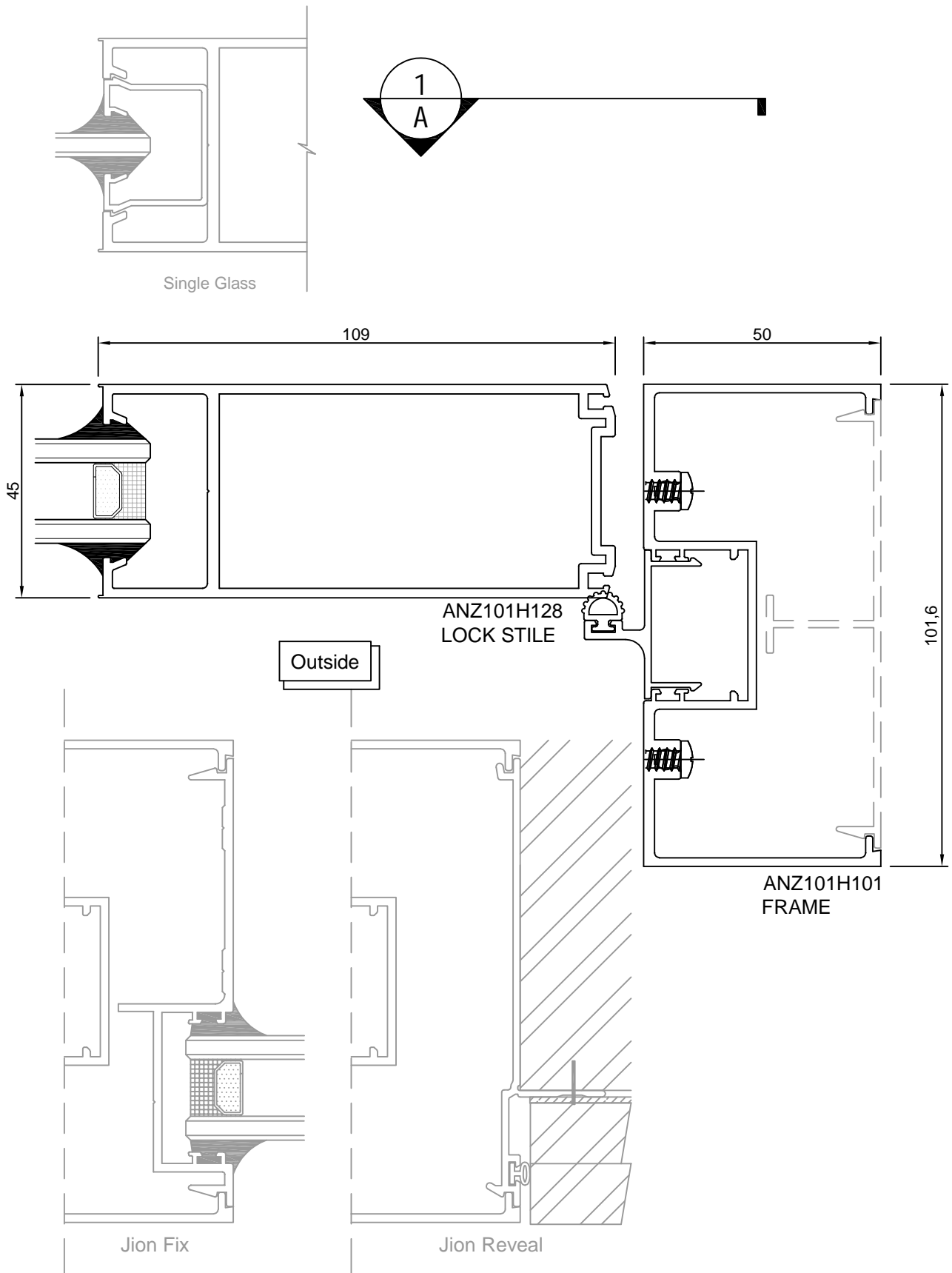

H45 Hinged Door

Product Detail

